



Digital Microphones

Solution-D

True Diamonds





Why digital signal processing?

With the development of the first digital recording equipment, the digitization of audio data began many years ago, at the end of the signal processing chain. By now, almost all audio signal processing components are available in digital form.

It is well-known that digital signals provide the necessary conditions for mathematically precise calculation and processing, allowing signals to be modified, copied, transmitted and stored as desired, with no loss of quality.

In contrast, analog signal processing is characterized by limited precision, error accumulation, a lack of redundant signal information, and no possibility to include error correction procedures. In the analog signal transmission chain, every processing step is thus associated with a deterioration of signal quality. This results in a progressive decrease in dynamic range, due to the introduction of noise voltages and nonlinear distortion.

Moreover, digital processing permits the performance of functions that are difficult or impossible to implement by means of analog signal processing. This is particularly the case with functions that require intermediate data storage.

A microphone technology milestone

With the Solution-D digital microphone system, Neumann has succeeded in bringing the dynamic range and signal fidelity of the best analog studio microphones into the digital domain, thus making possible an entirely digital signal chain for audio production.

Thanks to optimized A/D conversion, especially developed synchronization technology, and the capability of controlling standard microphone parameters and various integrated signal processing functions remotely, Solution-D meets the most demanding requirements of professional audio production. The fundamental principle of the technology permits recordings to be made with no „bottlenecks“ in the signal chain.

An extremely fast peak limiter integrated into the microphone provides constant protection from overloading. The Neumann A/D converter, which is likewise located in the microphone, eliminates the necessity of tedious experimentation with external converters and preamps. The Neumann sound, with optimal quality, is therefore captured directly on the hard drive. Users can rely on this, and thus have more time for the essentials.



TRUE NEUMANN SOUND:

The legendary Neumann sound in the digital realm. Pure Neumann capsule sound.

The System

Description

Components and interfaces

The power supply, remote control, synchronization, and signal and data transmission of the digital microphones conform to the AES42 standard. Neumann made a decisive contribution to the development of this standard, which supplies the necessary preconditions for the implementation of digital microphone technology.

A Solution-D digital microphone system consists of the following components: One or more digital microphones, a Digital Microphone Interface (DMI) and the Remote Control Software (RCS), which facilitates the operation and permits the remote control of the microphones. A PC or Mac can serve as the control computer, which of course can also be used simultaneously as Digital Audio Workstation for recording. A DMI permits connection to all subsequent devices that have an AES/EBU interface.

As an alternative to a DMI, a „Connection Kit“ can be used to connect Solution-D microphones to the AES/EBU or S/PDIF interface of a recording system. However, if a Connection Kit is used, it is not possible to control the microphone functions remotely. Thus a control computer is not required. In this case, if it is necessary to synchronize several microphones, a sample rate converter must be used.

All of the possible Solution-D system configurations are illustrated on the following pages.

If users later wish to take advantage of additional adjustable parameters and remotely controlled functions, the system can be expanded at any time through the acquisition of a separate DMI.

Remote control of standard microphone parameters

The DMI digital microphone interfaces permits familiar microphone settings such as the directional characteristic, pre-attenuation and low-cut filter to be controlled remotely and saved. Changing the settings of microphone parameters is greatly simplified, which makes it possible for settings to be tested rapidly from the monitoring position, in order to optimize the sound

quality. All of the settings can be saved together with any desired additional information, thus eliminating the necessity of keeping a hand-written log of the recording procedure.

Integrated digital audio signal processing

An A/D converter, developed and patented by Neumann, receives the signal directly from the capsule, and is optimized for the specific signal and impedance parameters of the capsule. Level matching that may be desired for subsequent equipment takes place in the digital domain, in the microphone. Analog components such as preamplifiers and A/D converters are thus no longer required, resulting in considerable cost savings.

The special A/D converter technology makes it possible to have the complete dynamic range of the microphone capsule available in the digital domain, with no restrictions. Setting gain levels is therefore no longer critical.

A particularly significant feature is the peak limiter function. Located for the first time in the most effective position, at the signal source, it reduces transient peaks as the level reaches 0 dBFS, when distortion would normally be inevitable. Analog microphones require extensive headroom in the subsequent signal path to handle such signal peaks, which are short but have a large amplitude. Independently of the peak limiter, a compressor/limiter can also be activated, permitting detailed adjustment via the corresponding parameters.

In addition, functions such as mute and phase reverse are also integrated into the microphone. Visual commands such as „On air“ are implemented by means of remotely controlled LEDs in the D-01 microphone. Acoustic commands in the form of various test signals can be used to facilitate line checks.

The firmware of all the digital microphones can be updated via uploading at any time.

Data transmitted by the microphone

Information transmitted by the microphone includes the name of the manufacturer, the model and serial



TRUE TO THE ORIGINAL:

The satisfaction of recording the uncolored original, with no „bottlenecks“ between the capsule and the recording system.



TRUE CONVERSION:

The guarantee of having one of the best A/D converters available.



number, the software version installed in the microphone, and the remotely controllable functions that are supported by the microphone. Status indicators such as „ready for operation“ and specific warning functions are also transmitted.

A/D conversion

Despite continuing improvements, integrated circuits available on the market still constitute a limiting factor in the conversion of audio data from analog to digital form. The best currently available delta-sigma A/D converters typically achieve a dynamic range of 115 dB to 120 dB, A-weighted, with a word length of 24 bits.

In comparison, a high-quality analog condenser microphone has a dynamic range of up to 130 dB. A/D conversion with a considerably better performance is therefore required, in order to prevent the addition of noise to the signal. At the same time, this process must be optimally adapted to the signal levels and source impedance found in the microphone.

If the A/D conversion is carried out only after the signal reaches the mixing console or other equipment, this is usually associated with loss of signal quality, since the conversion takes place only after the gain levels have been set. Headroom aspects and noise contributed by the microphone preamplifier and A/D converter thus affect the dynamic range.

Consequently, the development goal was to achieve high-quality digitization of the capsule signal directly in the microphone, so that level matching and other processing steps could be carried out in the digital realm. This is the only way of maintaining the full quality of the microphone signal.

Synchronization

The AES42 standard defines the following two methods of synchronizing the microphone with the receiver (e.g. a mixing console or a DMI digital microphone interface).

Mode 1: The microphone operates asynchronously, using the sampling rate of its internal quartz oscillator.

In this case, a sample rate converter is required at the receiver. This mode should be used only if mode 2 synchronization is not possible, since conventional sample rate converters often impair the dynamic range, and increase the latency time.

Mode 2: The microphone is synchronized with a master word clock. This can be either an external word clock or the internal word clock of the DMI. In this case a frequency/phase comparison with the master word clock is carried out in the AES42 receiver (DMI). A control signal is generated that is transmitted to the microphone via the remote control data stream, controlling the frequency of the quartz oscillator in the microphone.

Via the BNC output of the DMI, the internal word clock generator can be used to synchronize additional DMIs and subsequent processing equipment, such as a mixing console.

The microphones

The signal generated by the capsule is converted directly into a digital signal. The result is a digital output signal with 24 bits and, for example, a dynamic range of 130 dB (A-weighted) in the case of the D-01.

If required, the digital signal processing (DSP) functions integrated into the microphone can be configured and controlled remotely via the DMI digital microphone interface and the RCS remote control software. These functions include gain setting, changing the directional characteristic in the case of the D-01, pre-attenuation, a low-cut filter, a compressor/limiter with an additional de-esser function, and a peak limiter. Here in particular the digital approach can provide a significant advantage. The peak limiter, which receives the output signal almost directly from the capsule, functions as a completely automatic „safety valve“, permitting the safe utilization of the entire available dynamic range even in stressful recording situations.

External components that were previously required, such as analog preamplifiers and A/D converters, are no longer necessary.



TRUE HANDLING SAFETY:
Anti-clipping processing ensures handling safety, and reduces stress.

The System

Description

To permit clear identification, the microphones send information such as the name of the manufacturer, model, serial number and currently installed software version to the receiver.

The microphones are equipped with three-pin XLR connectors. A bidirectional signal conforming to the AES42 standard is transmitted, containing the balanced digital microphone output signal, the phantom power supply, and a remote control data stream, which includes a signal for synchronizing the microphones with a master clock.

The D-01 large-diaphragm digital microphone

Its 15 different remotely controlled directional characteristics and numerous additional features permit the D-01 to be optimally adapted to almost any recording situation. These comprehensive features demonstrate what can be achieved with digital microphone technology. The D-01 has a newly developed capsule, and is valued by users particularly for its hitherto unknown transparency and fidelity to detail.

The TLM 103 D large-diaphragm digital microphone

For many years the analog version of the TLM 103 D has played an important role for ambitious home recording and project studios. This microphone has made the Neumann sound available to a broad spectrum of demanding audio engineers and musicians. The TLM 103 D provides all of the sound features of its analog counterpart, in addition to the advantages of digital circuit technology described above.

The KMS 104 D and KMS 105 D digital vocal microphones

The microphones KMS 104 D and KMS 105 D are the transition of the well-established KMS 104/105 analog microphones into the digital domain. Based on the AES42 standard, these microphones are an ideal choice for live and on-stage applications. They provide all of the features of their analog counterparts.

Additionally, they offer the advantages of the digital circuit technology, such as extended dynamic range, a more robust operation (EMC safe) and the avoidance of clipping as a result of the integrated peak limiter/compressor. Use of one of the digital microphone interfaces together with the Remote Control Software (RCS) permits pre-programmed settings to be stored in the microphones.

The KMR 81 D digital shotgun microphone

The KMR 81 D is the transition of the well-established KMR 81 i shotgun microphone into the digital domain. It provides all of the features of its analog counterpart, which made it a favorite of sound engineers in movie and documentary productions. Additionally it offers the advantages of the digital circuit technology, such as extended dynamic range, a more robust operation (EMC safe) and the avoidance of clipping as a result of the integrated peak limiter/compressor. The settings for all functions can be recalled, set and stored in the microphone by using one of the digital microphone interfaces.

The KM D digital miniature microphones

The KM D microphones are the digital counterparts of the well-known, successful 180 miniature microphone series. In the analog realm, the KM 184 in particular is regarded as a standard for miniature condenser microphones, and is one of the best-selling of all Neumann microphones.

Eight different capsule characteristics are provided. The KM D microphones have a modular design, so that the KM D output stage can be combined with different capsules. All capsule heads can also be used with the analog KM A output stage.

The S/PDIF and AES/EBU Connection Kits

In addition to the DMI digital microphone interface, Neumann also provides „Connection Kits“ at an attractive price, to permit the simple connection of



TRUE TIME SAVINGS:

Reduced time requirements and personnel costs, particularly due to faster post production processing.



TRUE ECONOMY:

Lower investment costs, since separate A/D converters and preamps are no longer needed. This also means space and weight savings (e.g. in the OB van).



The System

Description

individual microphones to the widely used S/PDIF and AES/EBU interfaces. This allows numerous users to enjoy easy access to „Neumann sound direct to disk“, without the extensive functionality of a comprehensive DMI. Power is provided by an included plug-in power supply unit.

Of course it is possible to upgrade to a DMI at any time, in order to take advantage of the additional configuration capabilities and DSP functions.

The DMI-2 portable digital microphone interface

The DMI-2 portable is the ideal digital microphone interface solution for ENG and other field recording applications. It supports two digital microphones and allows adjustment of the Gain, Pre Attenuation and Low Cut filter settings at the device. The front panel display shows the selected gain and, by means of bar graphs, shows the current signal level and any gain reduction.

In addition to a word clock input and output, the DMIs also have an internal word clock generator. If no master word clock signal (e.g. from a mixing console) is present at the input, the DMI internal word clock is used automatically to synchronize the microphone channels, and the signal is switched to the word clock output.

Of course, these functions can also be operated via the RCS software. The computer is connected to the DMI via a USB port.

Microphone presets can be stored inside the DMI-2 portable and recalled for use in the field.

The DMI-8 digital microphone interface

The DMI-8, an eight-channel version of the digital microphone interface is considerably simplifying the setup for multi-channel applications.

In addition to the functions of the two-channel DMI-2 portable the DMI-8 also offers the following features:

- The capability of cascading up to 128 channels
- Level meter and gain setting on the front panel, operable even without a computer
- D-sub 25 outputs with Tascam® and Yamaha® pin assignments
- Optical ADAT® interface
- GN output for connection to multi-channel interfaces (MCA-ES to EtherSound®)

The DMI-8 offers several possibilities for easy integration into audio networks. The ES100 (DMI-8) module permits integration into EtherSound networks.

Multi-Channel Audio Interface MCA-ES

The MCA-ES permits the low-latency integration of up to 8 DMI-8s in an EtherSound network. This includes audio routing in the network, synchronization and remote control.

The RCS remote control software

All parameters are displayed on the screen, and can be changed at any time. During production, the audio engineer can monitor the operating status and parameters of all of the connected microphones and, if necessary, can change the settings quickly and easily.

The parameters displayed include the directional characteristic, pre-attenuation, low-cut filter, gain, various microphone status indicators, command indicators, and mute and phase reverse functions. Signal levels and the operation of the compressor or limiter can also be monitored on the screen.

Information transmitted by the microphone, such as the name of the manufacturer, model and serial number, is also displayed for clear identification of the connected microphones. Moreover, it is possible to input additional information such as the name of the sound source. Settings for the complete microphone setup can of course be stored and retrieved as required.



RCS REMOTE CONTROL SOFTWARE:

The most recent updates for the Solution-D digital microphone system software are available in the Downloads section of our website www.neumann.com.

The Principle

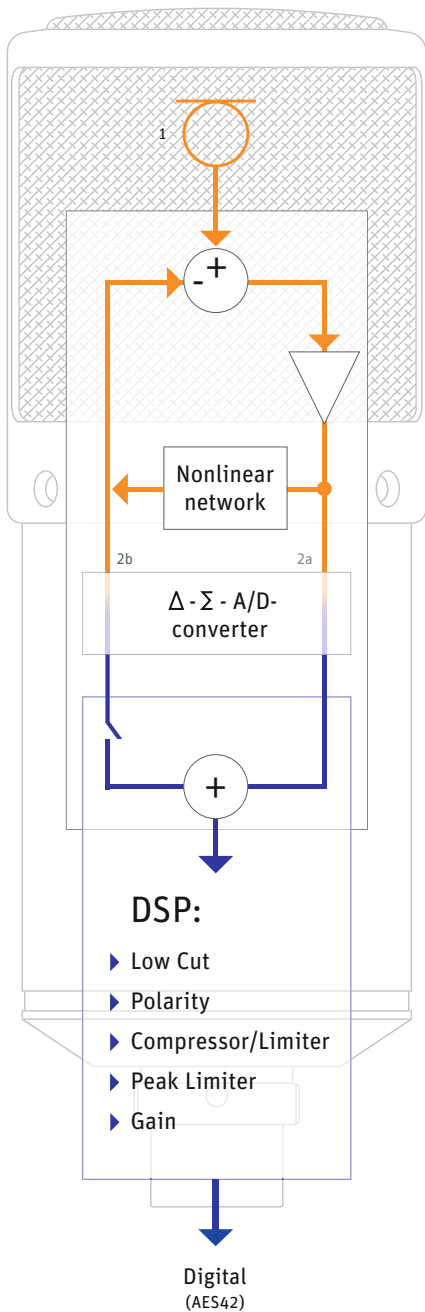

Analog capsule

Ideal matching of Neumann A/D-converter with microphone capsule

Neumann A/D converter:

Patented process

Dynamic range ≥ 140 dB

The capsule signal is transferred to the digital domain without any loss of quality.

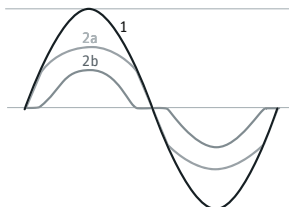

Entire range of functionality remote controlled

Synchronization with studio word clock

Clipping protection



Digital (AES42)



Connection kit configuration examples (mono only)



▶ D-01
Preset: 48 kHz³⁾



▶ KM D
Preset: 44.1, 48 or 96 kHz³⁾
(other preset frequencies selectable and storable via RCS and DMI)



▶ TLM 103 D
Preset: 48 kHz³⁾
(other preset frequencies selectable and storable via RCS and DMI)



▶ KMS 104 D / KMS 105 D
Preset: 48 kHz³⁾
(other preset frequencies selectable and storable via RCS and DMI)



▶ KMR 81 D
Preset: 48 kHz³⁾
(other preset frequencies selectable and storable via RCS and DMI)

The Family

Combinations

synchronization and remote control not possible):

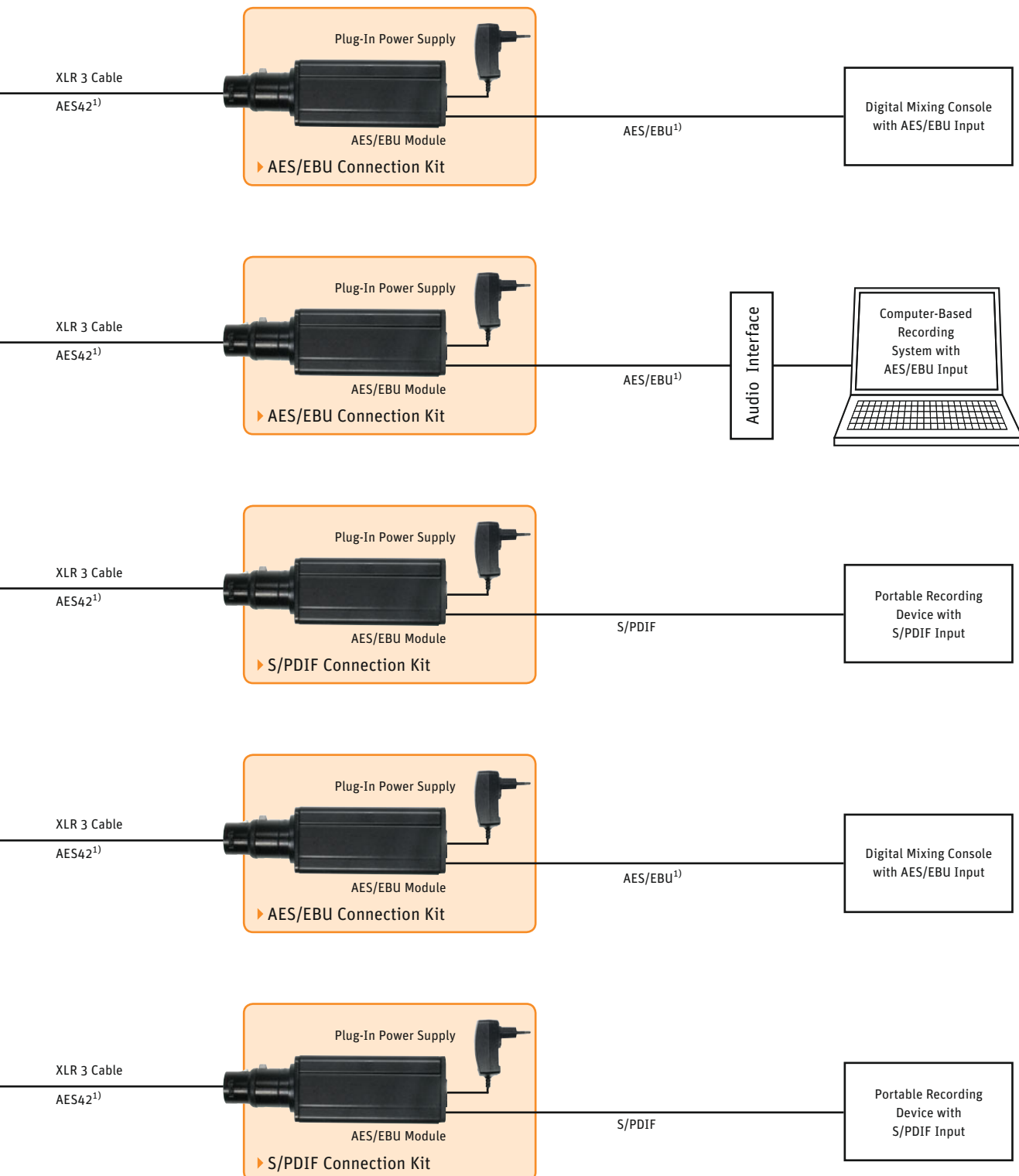

¹⁾ 110 ohms AES/EBU cable recommended

²⁾ nx = Nextel black

³⁾ word clock frequency without remote control



DMI configuration examples

(full functionality is provided, including microphone synchronization, as well as remote

▶ KMR 81 D/KM 120 D (MS Configuration)



XLR 3 Cable AES42¹⁾

XLR 3 Cable AES42¹⁾

▶ KMS 104 D/KMS 105 D



▶ D-01



XLR 3 Cable

AES42¹⁾



▶ KMD



XLR 3 Cable

AES42¹⁾

▶ TLM 103 D

The Family

Configurations

control and the display of parameters via PC or Mac):

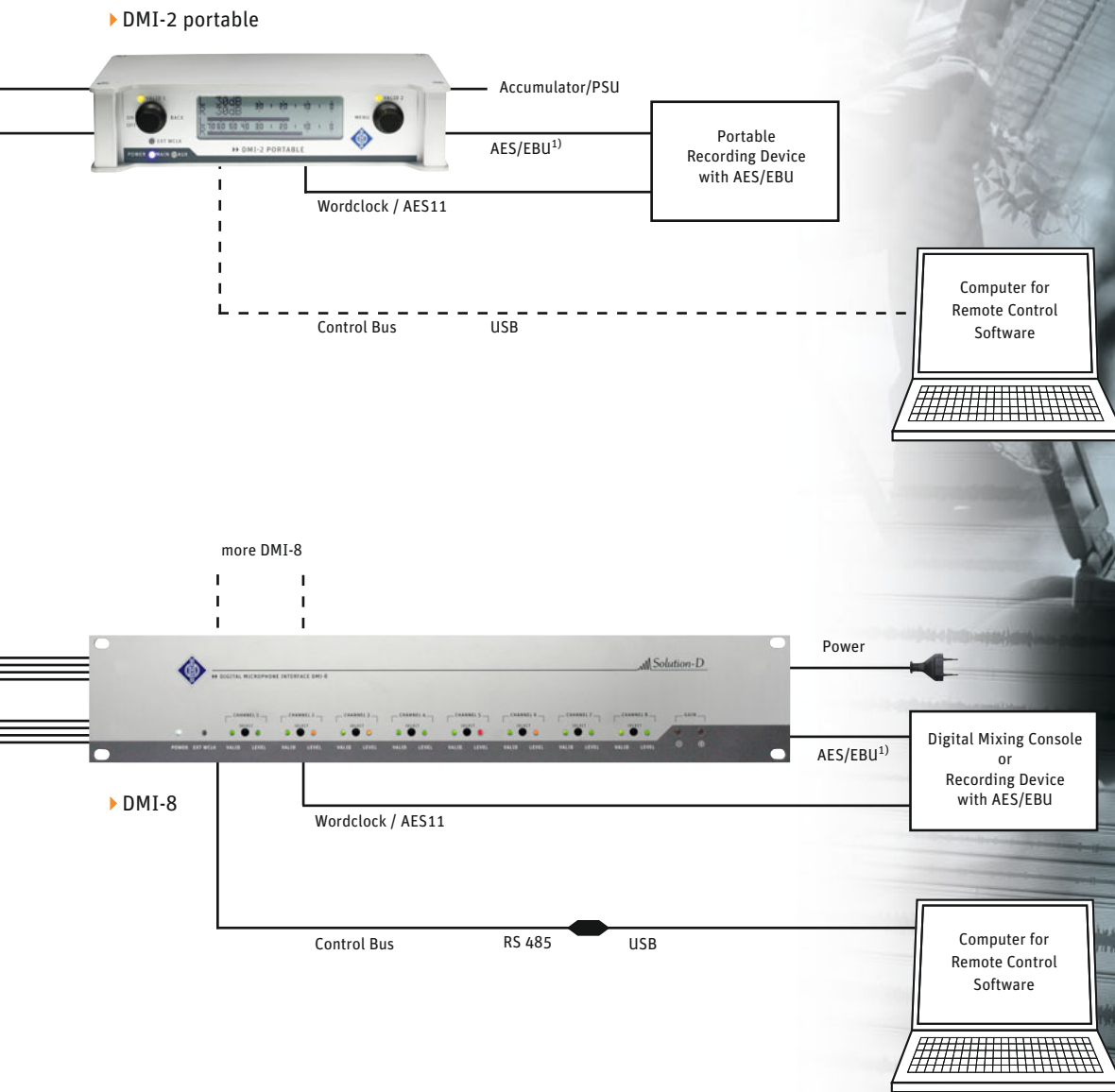

¹⁾ 110 ohms AES/EBU cable recommended



Configuration examples with DMI-8 in digital audio networks

▶ KMS 104 D/KMS 105 D



▶ D-01



XLR 3 Cable

AES42¹⁾



▶ KMD



XLR 3 Cable

AES42¹⁾

▶ TLM 103 D



▶ Up to 64 digital microphones

The Family

Configurations



► DMI-8

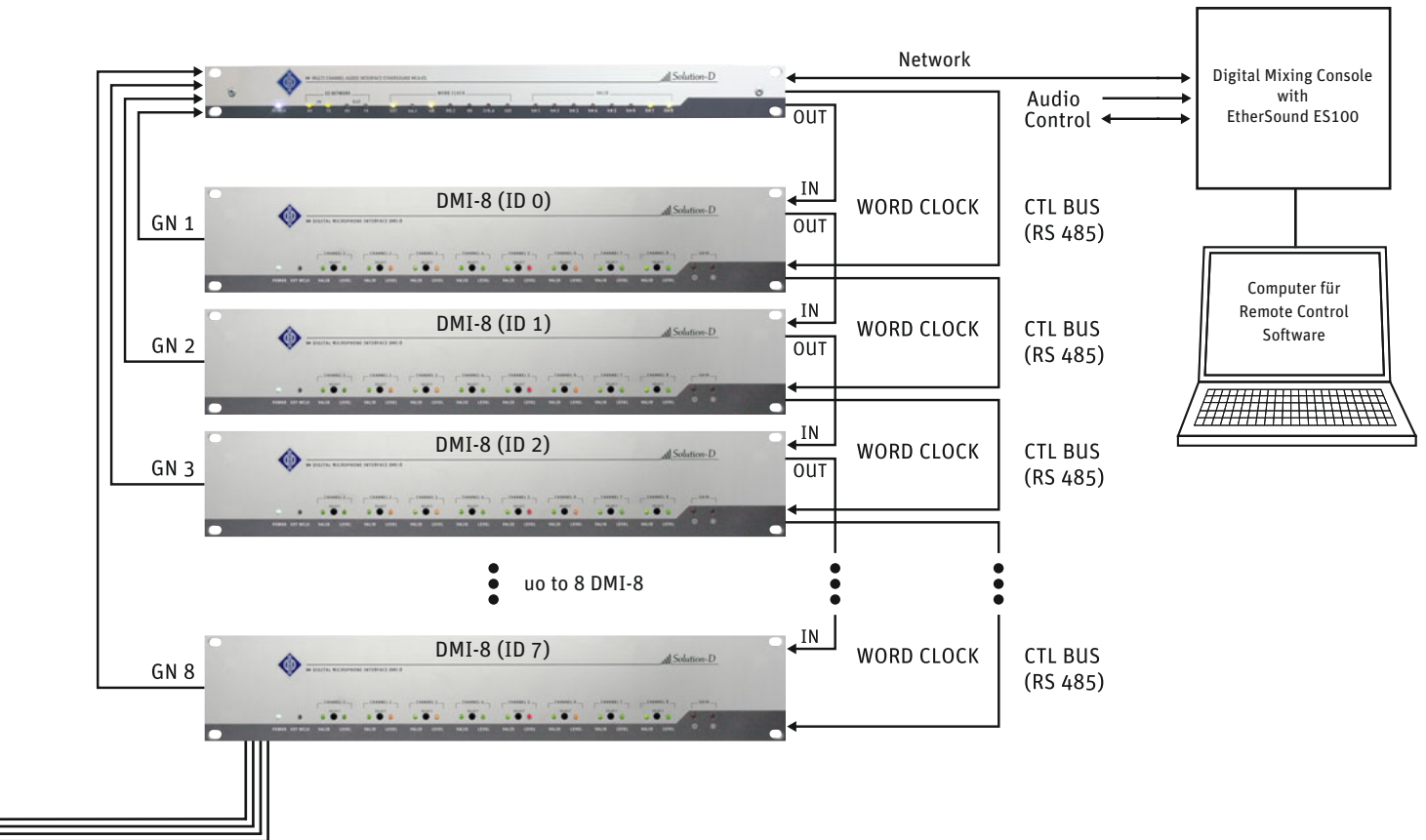

¹⁾ 110 ohms AES/EBU cable recommended



Configuration examples with DMI-8 in digital audio networks

▶ KMS 104 D/KMS 105 D



▶ D-01



XLR 3 Cable

AES42¹⁾



▶ KMD



XLR 3 Cable

AES42¹⁾

▶ TLM 103 D

▶ Up to 8 digital microphones

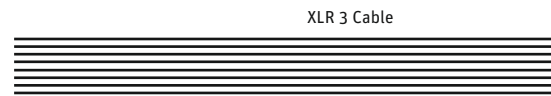

XLR 3 Cable

▶ Up to 8 digital microphones



XLR 3 Cable

AES42¹⁾

The Family

Configurations

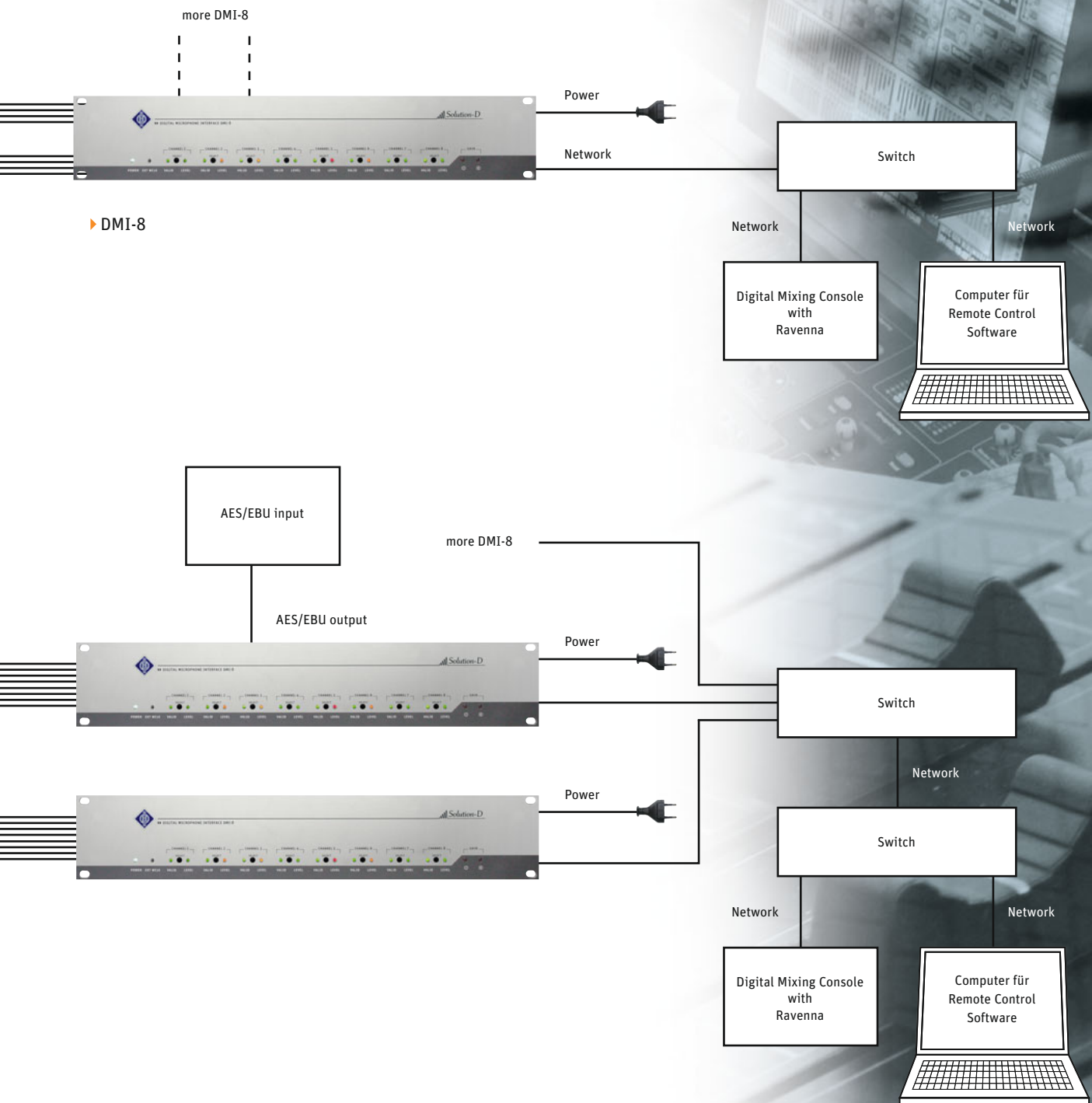

▶ DMI-8

¹⁾ 110 ohms AES/EBU cable recommended



Large Diaphragm Microphones



▶ D-01 microphone in wooden box

▶ TLM 103 D:
TLM 103 D microphone, stand mount, wooden box



▶ TLM 103 D mt:
TLM 103 D mt microphone, stand mount, wooden box



Miniature Microphones



▶ KK 131



▶ KK 143



▶ KK 145



▶ KK 183



▶ KK 184



▶ KK 185



▶ KK 131 nx



▶ KK 143 nx



▶ KK 145 nx



▶ KK 183 nx



▶ KK 184 nx



▶ KK 185 nx

Vocal Microphones

▶ KMS 104 D:
KMS 104 D microphone, stand mount, nylon bag



▶ KMS 104 D bk:
KMS 104 D bk microphone, stand mount, nylon bag



▶ KMS 105 D:
KMS 105 D microphone, stand mount, nylon bag



▶ KMS 105 D bk:
KMS 105 D bk microphone, stand mount, nylon bag



▶ KM 133 D
incl. SBK 133



▶ KM 183 D



▶ KM 184 D



▶ KM 185 D



▶ KM 133 D st
incl. SBK 133

Toolbox

Components & Sets



▶ KK 120

The KK... capsule heads can be used with the digital KMD(nx) as well as with the analog KMA(nx) output stage.



▶ KM D, Preset: 44.1, 48 or 96 kHz¹⁾



▶ KK 120 nx



▶ KK 133 nx



▶ KMD nx, Preset: 44.1, 48 or 96 kHz¹⁾



▶ KM 133 D nx ▶ KM 183 D nx ▶ KM 184 D nx ▶ KM 185 D nx incl. SBK 133

KM 183/184/185 D (nx) are delivered with wind-screen and clamp, also available as stereo sets.

Ch1 Microphone Properties

Manufacturer: Neumann
 Model: KM D
 Serial Number: 00000145
 Hardware Revision: 1.02
 Software Revision: 2.13
 Delay: 49 Samples

Clear Channel Close

40 Hz
 80 Hz
 160 Hz

0 dB
 -6 dB
 -12 dB
 -18 dB

Ch1 Gain

60dB
 50dB
 40dB
 30dB
 20dB
 10dB
 0dB
 0 dB

Close

off
 1kHz
 Pink Noise
 White Noise

Ch1 Compressor/Limiter

Flat / Deessing Mode
 flat 1k 2k 4k Hz

>100:1 - 0 - 0.05
 8:1 - -10 - 0.1 - 0.1
 6:1 - -20 - 0.3 - 0.2
 4:1 - -30 - 1 - 0.5
 3:1 - -40 - 3 - 1
 2:1 - -50 - 10 - 2
 1.5:1 - -60 - 30 - 5
 1.2:1 - -100 - 100 -

Ratio: 1.5:1 Threshold: -20dBFS Attack Time: 0.1 ms Release Time: 50 ms

Close

auto peak reset
 manual peak reset
 auto peak reset all channels
 manual peak reset all channels

Ch1 System

Mic PWR

Basic Settings

Function Controlled by
 RCS Userport
 Flat
 Blue
 Mute
 reserved

Red
 Blue

ADC-calibrate
 Reset
 SW Update
 Close

File Options Help

KM D

Low Cut 40 Hz

Pre Att 0 dB

Gain 0 dB

Stereo N/A

Test Sig off

WordClk 96k

Comp Limiter 1.5:1 -20dBFS 0.1 ms 50 ms

Peak Lim 0 dBFS

SYNC INT EXT

AES 42 VAL PWR

Red Blue Mute 180° System +20

1 Trumpet

¹⁾ word clock frequency without remote control



Toolbox

Components & Sets

Shotgun Microphones



▶ KMR 81 D nx:
KMR 81 D nx microphone,
windscreens, twist pack

Digital Microphone Interface



▶ DMI-2 portable (incl. RCS¹⁾)

Power Supplies



▶ Connection Kit S/PDIF
Contains: 1 S/PDIF Module,
Plug-In Power Supply



▶ Connection Kit AES/EBU
Contains: 1 AES/EBU Module,
Plug-In Power Supply



▶ DMI-8 (incl. RCS¹, without cables)



▶ MCA-ES (incl. RCS¹, without cables)

¹⁾ Remote Control Software

Applications

Application Hints

D-01

- Universally applicable, and particularly suitable for applications where maximum resolution and transparency are desired.

KK 120 + KM D

- MS-Stereo microphone, in combination with the KM 184 D
- Two crossed KK 120s in Blumlein technique
- Inconspicuous spot microphone with optimum attenuation of lateral sound sources
- Single microphone for two speakers facing each other

KK 131 + KM D

- For close miking of instruments when there is no need to attenuate extraneous noise, and in a balanced acoustic environment to record acoustic guitar, wind instruments, strings, percussion, and drums
- Flat frequency response for close miking, spot mic

KK 133 + KM D = KM 133 D

- Its special acoustic properties make this an ideal mic for most classical recordings
- Main mic, especially for capturing room acoustics
- A superb AB stereo pair for perfect balance of direct and reverberant sound
- Decca tree, setup with three microphones
- Spot mic for piano, wind instruments, organ, choir

KK 143 + KM D

- Polar response characteristic acts more like an omni. Therefore, it is an ideal tool to record larger instrument ensembles
- As AB stereo pair, especially in rooms with less than ideal acoustics
- As spot mic for strings, wind instruments, percussion, and Leslie speakers
- Acts very neutral when used close up to bass instruments, such as double bass, bass amps, guitar amps

KK 145 + KM D

- It naturally compensates for proximity effect
- Very neutral tonal balance during close miking of speech, as in TV, movie and video, PA
- Acts very neutral when used close up to bass instruments, such as double bass, bass amps, guitar amps, leslie speakers, toms

KK 183 + KM D = KM 183 D

- Ideal as AB stereo pair because of the flat frequency response in the diffuse sound field

- For close miking of instruments when there is no need to attenuate extraneous noise, and in a balanced acoustic environment to record acoustic guitar, wind instruments, strings, percussion, drums
- Main mic, especially for capturing room acoustics
- For stereo recordings with a baffle plate
- Spot mic for piano, wind instruments, organ, choir

KK 184 + KM D = KM 184 D

- For universal use, especially for recording situations when it is necessary to attenuate off-axis sound (mainly from the rear) from other nearby instruments.
- As XY and ORTF stereo pair
- Broadcasting mic for announcers
- Spot mic and overhead
- Close miking of strings, wind instruments, percussion, piano, Leslie speakers and guitar amps

KK 185 + KM D = KM 185 D

- Especially for recording situations when it is necessary to attenuate off-axis (lateral and rear) sound from other nearby instruments.
- As XY stereo pair
- Overhead, toms
- In situations that are susceptible to acoustic feedback
- To attenuate unwanted sound of nearby instruments
- Recording of speech, as in TV, movie and video productions, PA systems
- Produces especially warm and bass supporting sound for artists who perform in proximity effect range

TLM 103 D

- A universal cardioid mic
- Vocalist recording
- Announcer's mic for broadcasting/voice over
- Due to minimal self-noise: on-air mic for radio/broadcast, very low amplitude signals, radio drama, sampling, foley/sound effects
- Home recording and project studios
- Spot mic for wind instruments, strings, percussion, guitar amps, drum overhead

KMS 104/105 D

- For vocals and speech on stage
- For announcers, for broadcasting/dubbing
- Especially suitable for in-ear monitoring
- For environments susceptible to feedback

KMR 81 D

- Recordings for broadcasting/ENG, film and video productions
- Medium length shotgun spot mic in noisy surroundings
- Balanced weight during handheld and boom/fishpole operation



▶ **Delivery Range D-01**

D-01 Microphone in wooden box

Catalog No. D-01

D-01 Single Microphone ni 008482

Selection of Accessories D-01

Elastic suspension, EA 2 ni 008432
Elastic suspension, EA 2 mt blk 008428
Stand mount, SG 2 blk 008636

Auditorium hanger, MNV 87 ni 006804
Auditorium hanger, MNV 87 mt blk 006806

Popscreen, PS 15 blk 008472
Popscreen, PS 20 a blk 008488

Microphone cable, IC 3 mt blk 006543

▶ **Delivery Range KM D**

KM 183 D / KM 184 D / KM 185 D:

KM 183 D (nx) ... KM 185 D (nx) Microphone
WNS 100 Windscreen
SG 21 bk Stand mount
Wooden box

KM 133 D:

KM 133 D (nx/st) Microphone
SBK 133 Sound diffraction sphere
SG 21 bk Stand mount
Wooden box

KM D Stereo sets:

2x KM 183 D (nx) ... KM 185 D (nx) Microphone
2x WNS 100 Windscreen
2x SG 21 bk Stand mount
Wooden box

Catalog No. KM D

KM 133 D ni 008628
KM 133 D nx nx 008629
KM 133 D st st 008655

KM 183 D ni 008553
KM 183 D nx nx 008554
KM 183 D stereo set ni 008572
KM 183 D nx stereo set nx 008573

KM 184 D ni 008555
KM 184 D nx nx 008556
KM 184 D stereo set ni 008574
KM 184 D nx stereo set nx 008575

KM 185 D ni 008557
KM 185 D nx nx 008558
KM 185 D stereo set ni 008576
KM 185 D nx stereo set nx 008577

Selection of Accessories KM D

Output stage, KM D (44.1 kHz) ni 008578
Output stage, KM D nx (44.1 kHz) nx 008581
Output stage, KM D (48 kHz) ni 008579
Output stage, KM D nx (48 kHz) nx 008582
Output stage, KM D (96 kHz) ni 008580
Output stage, KM D nx (96 kHz) nx 008583

Analog output stage, KM A ni 008634
Analog output stage, KM A nx nx 008635

Capsule head, KK 120 ni 008589
Capsule head, KK 120 nx nx 008590
Capsule head, KK 131 ni 008591
Capsule head, KK 131 nx nx 008592
Capsule head, KK 133 ni 008639
Capsule head, KK 133 nx nx 008640
Capsule head, KK 143 ni 008593
Capsule head, KK 143 nx nx 008594
Capsule head, KK 145 ni 008595
Capsule head, KK 145 nx nx 008596
Capsule head, KK 183 ni 008566
Capsule head, KK 183 nx nx 008567
Capsule head, KK 184 ni 008568
Capsule head, KK 184 nx nx 008569
Capsule head, KK 185 ni 008570
Capsule head, KK 185 nx nx 008571

Elastic suspension, EA 2124 A mt blk 008433

Table stands, MF 2 blk 007266
Table stands, MF 3 blk 007321

Auditorium hanger, MNV 21 mt blk 006802

Double mount, DS 120 blk 007343
Stand mount, SG 21 bk blk 008613
Stand mount, SG 109 blk 008614
Swivel joint SG 110 nx nx 008611

Foam windscreen, WNS 100 blk 007323
Foam windscreen, WNS 110 blk 008535
Foam windscreen, WNS 120 blk 008427
Foam windscreen, WS 100 blk 006751

Popscreen, PS 15 blk 008472

Microphone cable, IC 3 mt blk 006543
Microphone cable, LC 4 (5 m) nx 008606

▶ **Delivery Range TLM 103 D**

TLM 103 D (mt) Microphone
SG 2 Stand mount
Wooden box

Catalog No. TLM 103 D

TLM 103 D ni 008603
TLM 103 D mt blk 008604

Selection of Accessories TLM 103 D

Elastic suspension, EA 1 ni 008449
 Elastic suspension, EA 1 mt..... blk 008450
 Stand mount, SG 2..... blk 008636

Auditorium hanger, MNV 87 ni 006804
 Auditorium hanger, MNV 87 mt blk 006806

Windscreen, WS 87 blk 006753

Popscreen, PS 15 blk 008472
 Popscreen, PS 20 a..... blk 008488

Microphone cable, IC 3 mt..... blk 006543

► Delivery Range KMS 104 D/KMS 105 D

KMS 104 D (bk) ... KMS 105 D (bk) Microphone
 SG 105 Stand mount
 Padded nylon bag

Catalog No. KMS 104 D/KMS 105 D

KMS 104 D ni 008643
 KMS 104 D bk..... blk 008644

KMS 105 D ni 008645
 KMS 104 D bk..... blk 008646

Selection of Accessories KMS 104 D/ KMS 105 D

Microphone cable, IC 3 mt..... blk 006543
 Adapter cable, AC 25 blk 006600
 Adapter cable, AC 27 blk 006602

Table stand, MF 3 blk 007321
 Windscreen, WSS 100..... blk 007352

► Delivery Range KMR 81 D nx

KMR 81 D nx Microphone
 WS 81 Windscreen
 Twist pack

Catalog No. KMR 81 D nx

KMR 81 D nx..... nx 008648

Selection of Accessories KMR 81 D nx

Elastic suspension, EA 2124 A mt..... blk 008433
 Auditorium hanger, MNV 21 mt..... blk 006802
 Stand mount, SG 21 bk blk 008613

Microphone cable, IC 3 mt..... blk 006547
 Windscreen set, WKE 81 Set..... gr 539381

► Interfaces and Power Supplies

Connection Kit AES/EBU:

AES/EBU Module
 Plug-In Power Supply

Connection Kit S/PDIF:

S/PDIF Module
 Plug-In Power Supply

Connection Kit AES/EBU 008584

Connection Kit S/PDIF 008585

DMI-2 portable:

Digital Microphone Interface DMI-2 portable
 RCS software and USB driver

Interface, DMI-2 portable 542404

Plug-In Power Supply, N DMI-2 P 558090

12 V DC (100 - 240 V) for DMI-2 portable,
 4 power socket adapter included
 (EU, UK, US, AUS)

DMI-8:

Digital Microphone Interface DMI-8
 RCS software and USB driver
 no accessories

DMI-8 ES100:

Digital Microphone Interface DMI-8 ES100
 RCS software and USB driver
 no accessories

Interface, DMI-8
 (EU 230 V, US 117 V or UK 230 V 533130

Interface, DMI-8 ES100
 (EU 230 V, US 117 V or UK 230 V) 551650

Network Module, ES100 (DMI-8) 539398

DMI-8 connection set (USB cable,
 RJ 45 patch cable, USB 485 converter 533126
 (not included in the supply schedule)

MCA-ES:

Multi-Channel Audio Interface EtherSound MCA-ES
 RCS software and USB driver
 no accessories

Interface, MCA-ES 551600

A complete survey and detailed descriptions of all accessories are contained in the accessories catalog

Meaning of color codes:

ni = nickel, nx = nextel black, blk = black, gr = gray,
 st = stainless steel



▶ General Specifications of the Solution-D microphones

Interface: AES42

Remote controlled functions:

- Polar pattern¹⁾
- Pre-attenuation: **0**/-6/-12/-18 dB²⁾
- High-pass filter (Low-cut): Off/**40**/80/160 Hz
- Digital gain: 0...**10**...63 dB in steps of 1 dB, clickless
- Test signals: **Off**/1 kHz (-48 dBFS)/Pink noise (-35 dBFS)/White noise (-43 dBFS)
- Parametric Compressor/Limiter: **On**/Off
- Lower cut-off frequency of the working range: **Flat**/1 kHz/2 kHz/4 kHz
- Max. gain reduction: Flat mode > 63 dB, 1 kHz/2 kHz/4 kHz > 20 dB
- Compression ratio: 1.2:1/1.5:1/**2:1**/3:1/4:1/6:1/8:1/> 100:1
- Threshold: -63 dBFS...-**10**...0 dBFS, in steps of 1 dB
- Attack time: 0/0.1/0.3/1/3/10/30/**100** ms
- Release time: 0.05/0.1/0.2/**0.5**/1/2/5 s (for a level change of approx. 10 dB)
- Peak limiter: **On**/Off
- Attack time: -160 μs (negative)
- Release time: approx. 50 ms to 150 ms (signal-dependent)
- Threshold: Off: 0 dBFS fixed/On: -15 dBFS to **0 dBFS**, in steps of 1 dB

- Mute: On/**Off**
- Phase (polarity): **0°**/180°
- Signal light³⁾: LED (red¹⁾ and blue), brightness adjustable
- Sampling rates: 44.1/**48**/88.2/96/176.4/192 kHz (Factory setting depending on version supplied.)
- System functions, firmware download

A/D conversion: Neumann process (patented), 28-bit internal word length

Digital signal processing: Fixed-point, variable internal word length 28 bits to 60 bits

Synchronization:

- Asynchronous operation (free-running, AES42 - Mode 1), basic frequency accuracy: ± 25 ppm
- Synchronous operation (AES42 - Mode 2), pulling range: Min. ± 100 ppm

Power supply (phantom power complying with AES42)

Output: XLR3M, 24 bits as per AES/EBU (AES3)

¹⁾ D-01 only
²⁾ Factory settings are indicated in bold. If the DMI is used, they can be changed at any time via the Remote Control Software.
³⁾ KMS microphones without signal light

▶ KM D /KM A + KK... Specifications

Typ	▶ KK 131	▶ KK 133	▶ KK 183	▶ KK 143	▶ KK 184	▶ KK 145	▶ KK 185	▶ KK 120
Acoustical operating principle	pressure transducer			pressure gradient transducer				
Directional pattern	omni free-field equalized	omni dif-fuse-field equalized	omni dif-fuse-field equalized	cardioid wide	cardioid	cardioid low frequency roll-off	hyper-cardioid	figure-8, side-fire
Frequency range	20 – 20000 Hz							
Sensitivity (KM A) ¹⁾	12 mV/Pa	15 mV/Pa	12 mV/Pa	15 mV/Pa	15 mV/Pa	14 mV/Pa	10 mV/Pa	12 mV/Pa
Sensitivity (KM D) ¹⁾²⁾	-41 dBFS	-40 dBFS	-41 dBFS	-39 dBFS	-39 dBFS	-40 dBFS	-42 dBFS	-41 dBFS
Signal-to-noise ratio ²⁾ , CCIR ³⁾	70 dB	66 dB	69 dB	70 dB	70 dB	70 dB	69 dB	69 dB
Signal-to-noise ratio ²⁾ , A-weighted ³⁾	81 dB	79 dB	81 dB	81 dB	81 dB	80 dB	78 dB	79 dB
Equivalent noise level, CCIR ³⁾	24 dB	28 dB	25 dB	24 dB	24 dB	24 dB	25 dB	25 dB
Equivalent noise level, A-weighted ³⁾	13 dB	15 dB	13 dB	13 dB	13 dB	14 dB	16 dB	15 dB
Max. SPL (KM A) ¹⁾ for THD <0.5%	140 dB	138 dB	140 dB	138 dB	138 dB	138 dB	142 dB	140 dB
for THD <0.5% with preattenuation	150 dB	148 dB	150 dB	148 dB	148 dB	148 dB	152 dB	150 dB
Max. SPL (KM D) at 0 dBFS ¹⁾	135 dB	134 dB	135 dB	133 dB	133 dB	134 dB	136 dB	135 dB
Max. SPL (KM D) with 18 dB preatt ¹⁾³⁾	153 dB	152 dB	153 dB	151 dB	151 dB	152 dB	154 dB	153 dB
Current consumption (KM A)	max. 3.5 mA (P48)							
Current consumption (KM D)	max. 150 mA (DPP)							
Matching connector	XLR 3 M							
Weight (output stage)	70 g							
Dimensions (L x Ø) (microphone)	108 mm x 22 mm	128 mm x 22 mm	108 mm x 22 mm	108 mm x 22 mm	108 mm x 22 mm	108 mm x 22 mm	108 mm x 22 mm	130 mm x 24 mm
Weight (capsule only)	11 g	49 g	11 g	15 g	15 g	15 g	19 g	37 g
Dimensions (L x Ø) (capsule only)	18 mm x 22 mm	38 mm x 22 mm	18 mm x 22 mm	18 mm x 22 mm	18 mm x 22 mm	18 mm x 22 mm	18 mm x 22 mm	40 mm x 24 mm

¹⁾ at 1 kHz
²⁾ re 94 dB SL
³⁾ according to IEC 60268-1; CCIR-weighting according to CCIR 468-3, quasi peak; A-weighting according to IEC 61672-1, RMS

Technical Data

► D-01 Specifications

Acoustic transducer: K 07 large double-diaphragm capsule, diameter 30 mm with protected internal electrodes
15 remote controllable polar patterns, from omni to cardioid to figure-8

Frequency response: 20 Hz to 20 kHz
Free-field sensitivity¹⁾²⁾: -44 dBFS
Equivalent noise level, CCIR³⁾: 19 dB
Equivalent noise level, A-weighted³⁾: 8 dB-A
Signal-to-noise ratio²⁾, CCIR³⁾: 75 dB
Signal-to-noise ratio²⁾, A-weighted³⁾: 86 dB
Maximum SPL at 0 dBFS: 138 dB SPL
Dynamic range, A-weighted³⁾: 130 dB

Latency:

44,1/48 kHz: 52 samples
88,2/96 kHz: 61 samples
176,4/192 kHz: 121 samples (AES3)

Supply voltage range: +6 V to +10,5 V
Current consumption: max. 220 mA

Weight: approx. 700 g, Diameter: 63.5 mm, Length: 185 mm

► TLM 103 D Specifications

Acoustic transducer: Pressure gradient transducer
Directional characteristic: Cardioid

Frequency response: 20 Hz to 20 kHz
Free-field sensitivity¹⁾: -39 dBFS
Equivalent noise level, CCIR³⁾: 17.5 dB
Equivalent noise level, A-weighted³⁾: 7 dB-A
Signal-to-noise ratio²⁾, CCIR³⁾: 76.5 dB
Signal-to-noise ratio²⁾, A-weighted³⁾: 87 dB
Maximum SPL at 0 dBFS: 134 dB SPL
Dynamic range, A-weighted³⁾: 127 dB

Latency:

44,1/48 kHz: 52 samples
88,2/96 kHz: 61 samples
176,4/192 kHz: 121 samples (AES3)

Preset:

Sampling rates: 48 kHz
Gain: 10 dB
Compressor on, Attack time 100 ms, Release time 0.5 s,
Threshold -10 dBFS, Ratio 2:1

Supply voltage range: +6 V to +10,5 V
Current consumption: max. 150 mA

Weight: approx. 460 g, Diameter: 60 mm, Length: 132 mm

► KMS 104/105 D Specifications

Acoustic transducer: Pressure gradient transducer
Directional characteristic: Cardioid/Supercardioid

Frequency response: 60 Hz to 20 kHz
Free-field sensitivity¹⁾: -47 dBFS
Equivalent noise level, CCIR³⁾: 27 dB
Equivalent noise level, A-weighted³⁾: 16 dB-A
Signal-to-noise ratio²⁾, CCIR³⁾: 67 dB
Signal-to-noise ratio²⁾, A-weighted³⁾: 78 dB
Maximum SPL at 0 dBFS: 141 dB SPL
Dynamic range, A-weighted³⁾: 125 dB

Latency:

44,1/48 kHz: 41 samples
88,2/96 kHz: 49 samples
176,4/192 kHz: 99 samples

Preset:

Sampling rates: 48 kHz
Gain: 10 dB
Compressor on, Attack time 100 ms, Release time 0.5 s,
Threshold -10 dBFS, Ratio 2:1

Supply voltage range: +7 V to +10,5 V
Current consumption: max. 150 mA (DDP)

Weight: approx. 300 g, Diameter: 48 mm, Length: 180 mm

► KMR 81 D Specifications

Acoustic transducer: Interference transducer
Directional characteristic: Supercardioid/lobe

Frequency response: 20 Hz to 20 kHz
Free-field sensitivity¹⁾: -36 dBFS
Equivalent noise level, CCIR³⁾: 21 dB
Equivalent noise level, A-weighted³⁾: 9 dB-A
Signal-to-noise ratio²⁾, CCIR³⁾: 73 dB
Signal-to-noise ratio²⁾, A-weighted³⁾: 85 dB
Maximum SPL at 0 dBFS: 123 dB SPL
Dynamic range, A-weighted³⁾: 114 dB

Latency:

44,1/48 kHz: 41 samples
88,2/96 kHz: 49 samples
176,4/192 kHz: 99 samples

Preset:

Sampling rates: 48 kHz
Gain: 10 dB
Compressor on, Attack time 100 ms, Release time 0.5 s,
Threshold -10 dBFS, Ratio 2:1

Supply voltage range: +7 V to +10.5 V
Current consumption: max. 150 mA

Weight: approx. 90 g, Diameter: 22 mm, Length: 212 mm

► DMI-2 portable (Digital Microphone Interface) Specifications

Ports: 2x AES42 IN (XLR3F), 1x AES/EBU (AES3) OUT (XLR3M),
2x Word Clock IN/OUT (BNC), 1x Remote Control (USB)

Indicators: Monochrome display, bar graphs for gain, level and gain reduction, LED's for Power, Battery status, Synchronization and Valid

Phantom power (DPP): +10 V, max. 250 mA per channel, short-circuit proof

Remote control data: Pulses (+2 V), superimposed on the phantom power, approx. 750 bits/s or 9,600 bits/s (depending on the microphone)

Microphone synchronization: AES42 - Mode 2 (synchronous mode)
Microphone clock control via PLL

DMI-2 portable Synchronization: automatically to an external word clock or AES11 signal, if present, otherwise the internal word clock generator is activated

Word clock (or AES11) input: BNC
- Vin: >100 mV at 75 ohms



Word clock (or AES11) output: BNC
- Vout: = Vin (external synchronization)
- Vout: approx. 1.5 V at 75 ohms (internal word clock generator)

Internal word clock generator: 44.1 / 48 / 88.2 / 96 kHz/176.4 / 192 kHz, Accuracy ± 25 ppm

Control elements: 2x push-switch rotary encoder
CTL (Control interface): 1x USB port

Power supply: DC 10-18 V (Hirose) , NP1 rechargeable battery or AC/DC converter

Power consumption: <8 VA

Dimensions: (W x H x D) 186 x 44 x 126 mm

Weight: approx. 625 g.

▶ DMI-8 (Digital Microphone Interface) Specifications

AES42 inputs: 8x XLR3F , Audio data in accordance with AES/EBU (AES3) data format, Digital phantom power (DPP), Remote control data

Outputs: 2x SUB-D 25, AES/EBU (AES3) data format, Yamaha® and Tascam® pinout, 1x Toslink, ADAT® format up to 48 kHz, 1x RJ 45, GN format up to 192 kHz, incl. power-out pin: approx. +15 VDC, max.1 A, short-circuit-proof

Microphone synchronization: AES42 – Mode 2 (synchronous mode)
Microphone clock control via PLL

DMI-8 Synchronization: automatically to an external word clock or AES11 signal, if present, otherwise the internal word clock generator is activated.

Word clock (or AES11) input: BNC
- Vin: >100 mV at 75 ohms
Word clock (or AES11) output: BNC
- Vout: = Vin (external synchronization)
- Vout: approx. 1.5 V at 75 ohms (internal word clock generator)

Internal word clock generator: 44.1/48/88.2/96/176.4/192 kHz

Indicators: Power, Ext Word Clock, Valid,Level (microphone)

Control elements: 8x Channel Select, GAIN +/-

Control bus: 2 x RJ 45 ports; connection to computer USB port via the Neumann USB 485 interface converter; connected in parallel for the purpose of cascading. RS 485 with additional power-out pin (approx. +11.3 V, max. 500 mA)

Device address (ID): 0 to 15, adjustable via coding switch on the back of the device

Free slot for digital audio network cards (EtherSound ES 100, Ravenna in preparation)

User port: 9-pin sub-D, 1 switch function per channel (Mute and/or Light 1/Light 2 selectable)

Power supply: 90 V to 240 V; 50/60 Hz

▶ MCA-ES (Multi-Channel Audio Interface EtherSound) Specifications

EtherSound ports IN/OUT: 2x RJ 45, ES100 is limited to sampling frequencies of 44.1/48 kHz by the included Auvitrans EtherSound module (higher sampling frequencies on request).

GN inputs: 8x RJ 45, DMI-8 audio data using sample frequencies of 44.1/48/88.2/96/176.4/192 kHz and power supply for the MCA-ES

MCA-ES Synchronization: automatically to the EtherSound network connected to the IN port or as primary master of the network to an external

word clock or AES11 signal, if present, otherwise the internal word clock generator is activated

Word clock (or AES11) input: BNC
- Vin: >100 mV at 75 ohms
Word clock (or AES11) output: BNC
- Vout: approx. 1.5 V at 75 ohms (internal word clock generator)

Internal word clock generator: 44.1/48/88.2/96 kHz/176.4/192 kHz

Indicators: Power, ES Network Status, Ext Word Clock, Word Clock Frequency, Valid GN 1..8

Control bus: 2 x RJ 45 ports; connection to the DMI-8 respectively the computer USB port via the Neumann USB 485 interface converter; connected in parallel for the purpose of cascading. RS 485 with additional power-out pin (approx. +11.3 V, max. 500 mA)

Device address (ID): 0 to 15, adjustable via coding switch on the back of the device

Power supply: DC 15 V
Power consumption: < 6 VA

Dimensions: (W x H x D) 483 x 44 x 210 mm
Weight: approx. 1.5 kg

▶ Features of the RCS (Remote Control Software)

Communication via USB port (Win 2000/98SE/ME/XP, Vista, MAC OS version 8.6...10 on PowerPC) or control data via digital audio network (EtherSound ES100 or Ravenna) (Windows)

Up to 8 channels displayed simultaneously on the screen

Controllable functions: polar pattern, low-cut, pre-attenuation, gain, test signals, limiter/compressor/de-esser, peak limiter, phase reverse, mute, sampling rate, synchronization mode, signal lights,...

Display: peak level meter, gain reduction meter for compressor/limiter/de-esser and peak limiter, microphone properties (manufacturer, model, serial number, hardware and software revision, internal latency time), DMI properties, status signals (overload, limiter active, data valid, sync locked, power on)

Saving/Loading of configurations
Individual channel labelling

Software update of Neumann microphones and DMI device

▶ Connection Kit S/PDIF (AES/EBU) Specifications

Connector: input XLR3F, output Cinch (XLR3M)
Weight: approx. 96 g (S/PDIF), approx. 130 g (AES/EBU)
Width: 32 mm, Height: 26 mm, Length: 105 mm
Power supply: 90-240 V, 50/60 Hz

For remote control of DSP functions you have to use the DMI.

All data with respect to 0 dB pre-attenuation and 0 dB gain.

¹⁾ at 1 kHz

²⁾ re 94 dB SPL

³⁾ according to IEC 60268-1:

CCIR-weighting according to CCIR 468-3, quasi peak;
A-weighting according to IEC 61672-1, RMS

Diagrams

► D-01

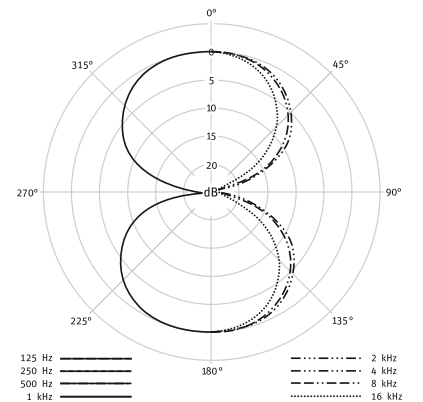
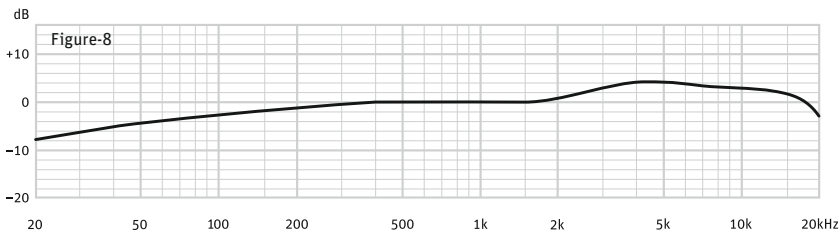
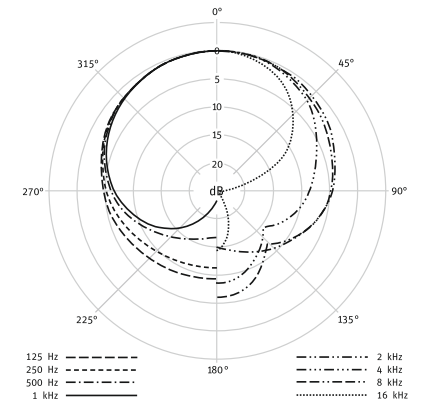
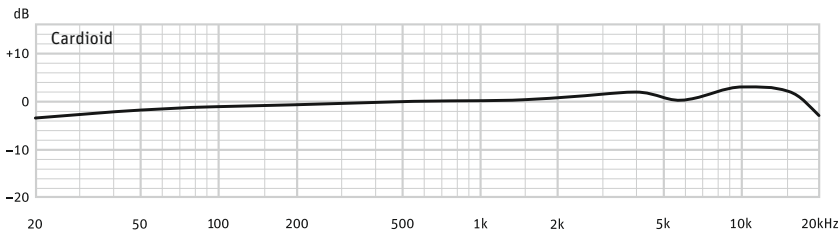
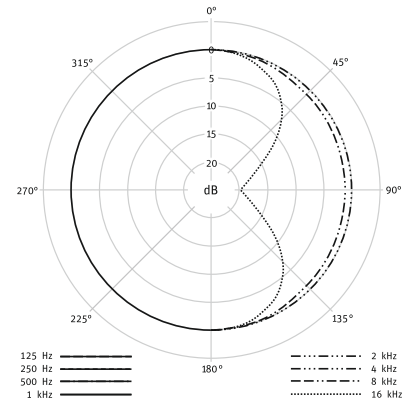
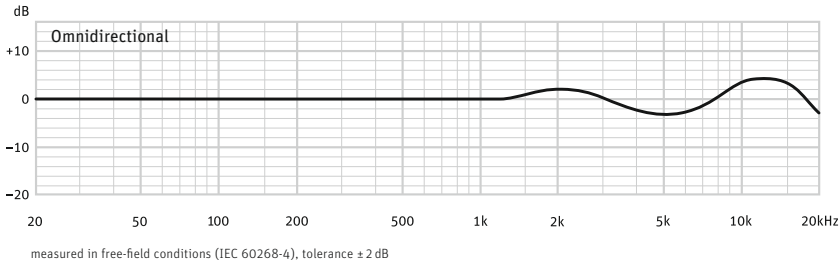

► KM D / KM A + KK...

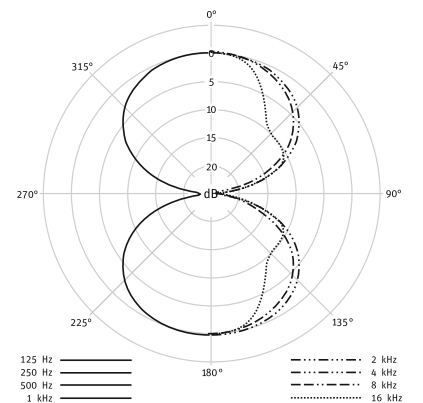
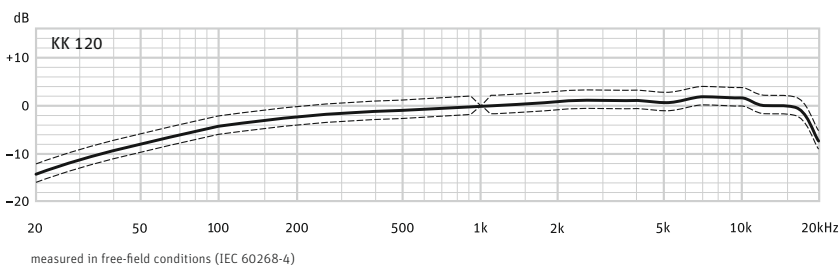

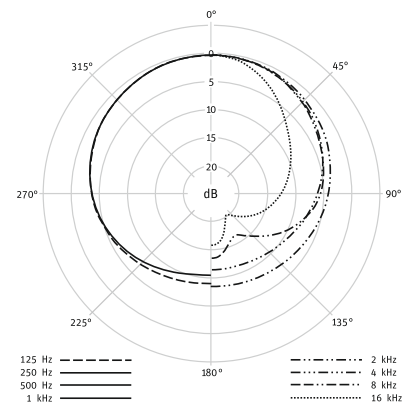
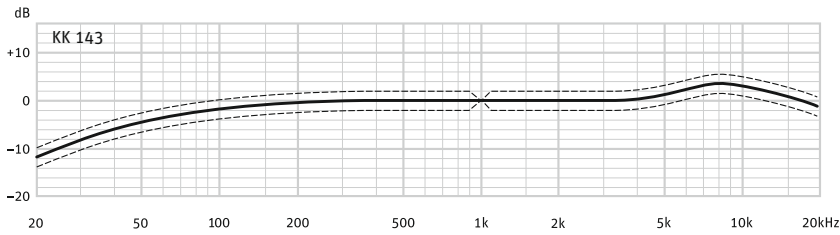
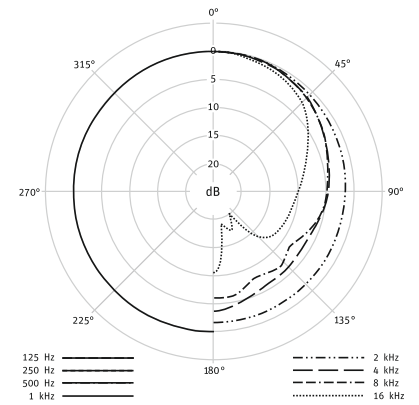
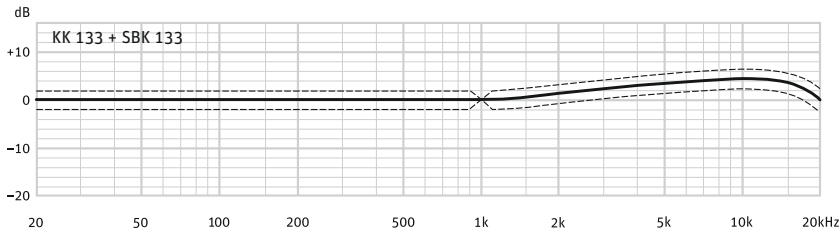
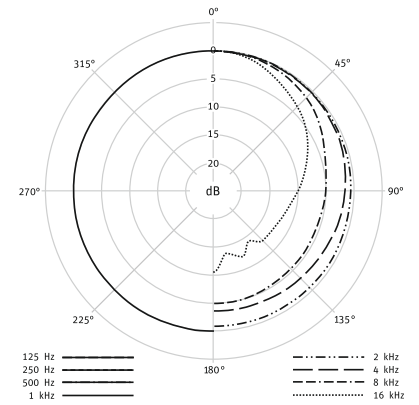
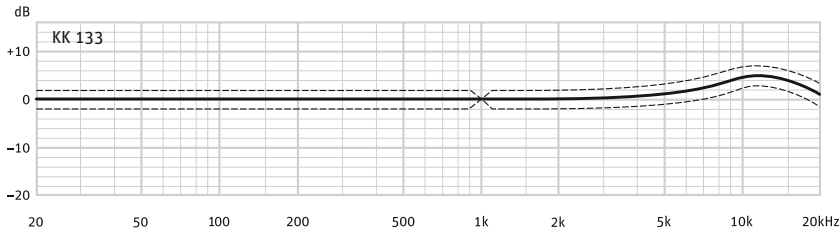
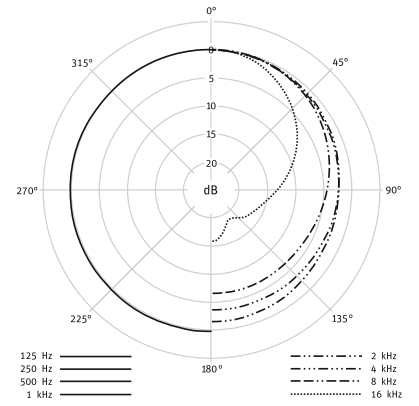
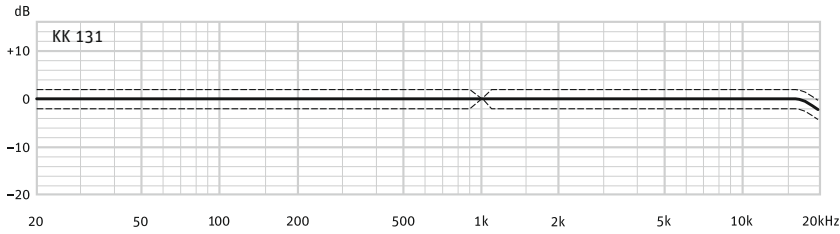

Diagrams

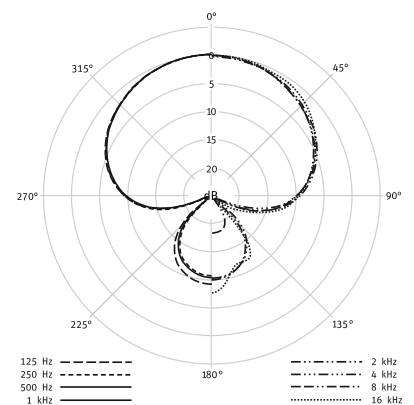
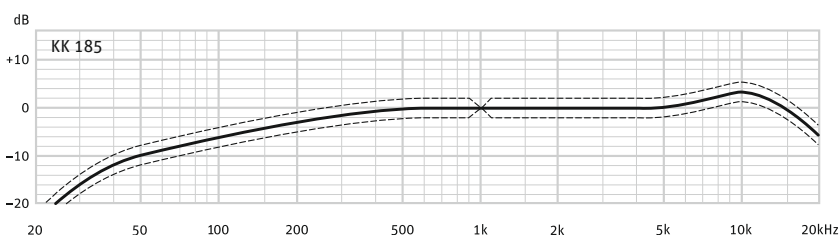
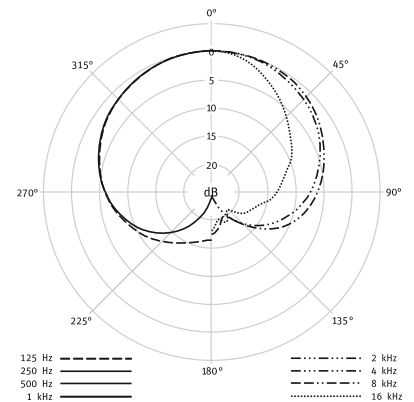
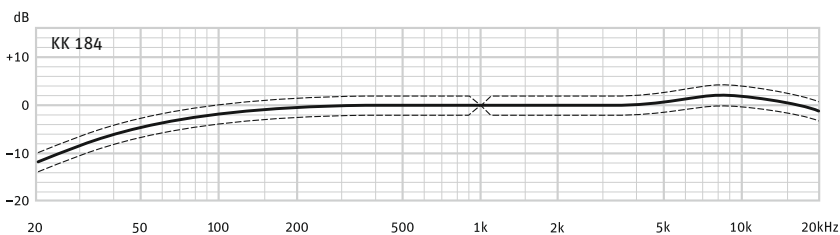
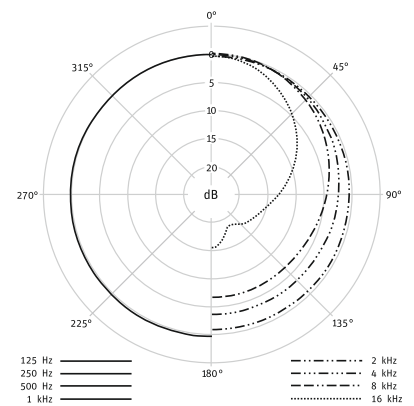
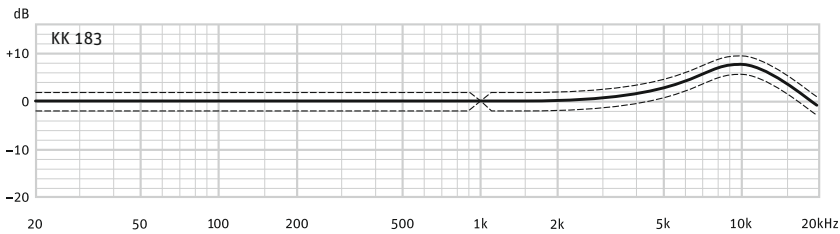
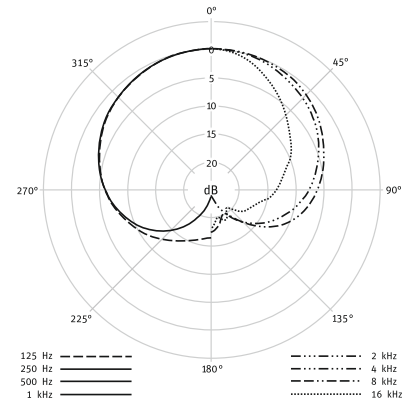
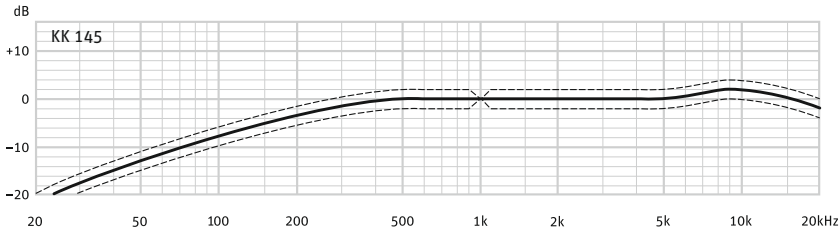

▶ TLM 103 D

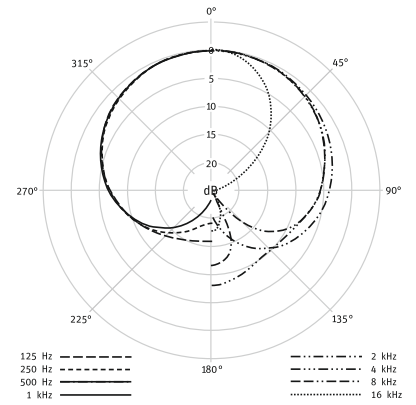
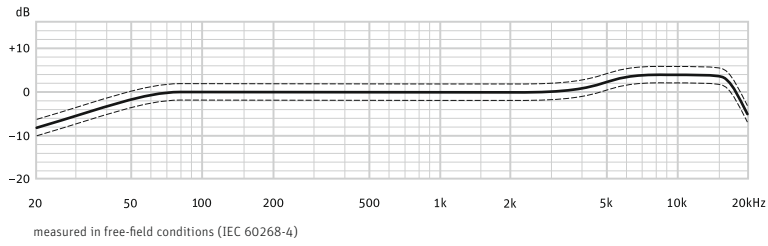

▶ KMS 104 D

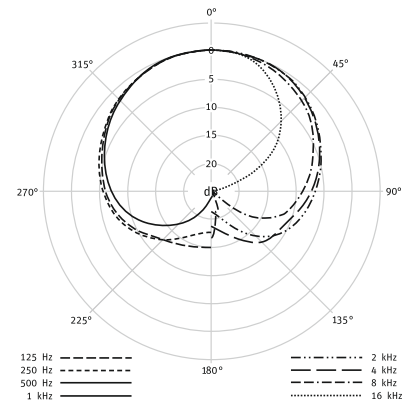
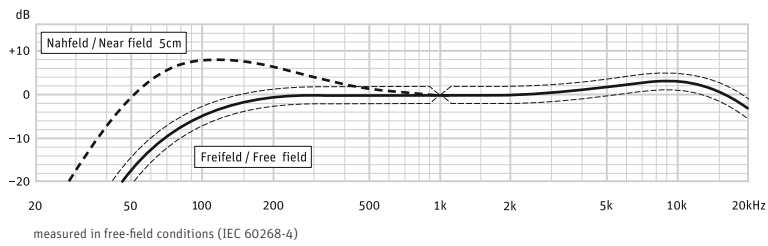

▶ KMS 105 D

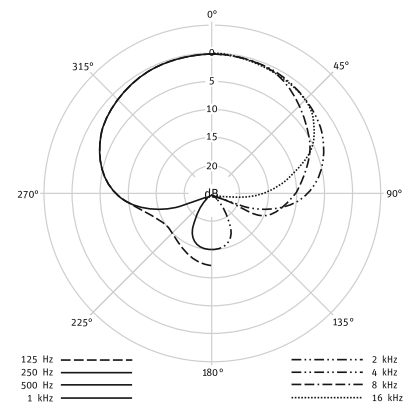
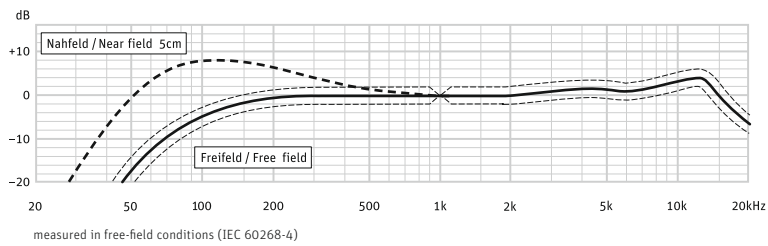

▶ KMR 81 D

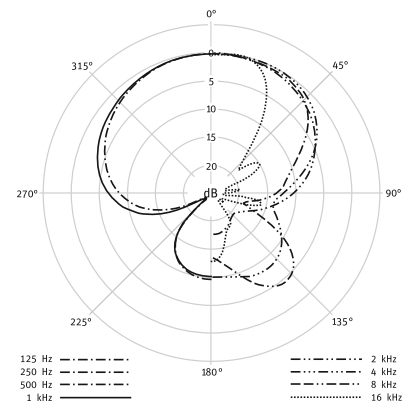
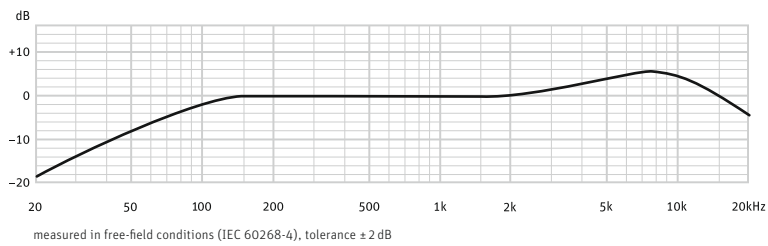

Georg Neumann GmbH • Ollenhauerstr. 98 • 13403 Berlin • Germany • Tel: +49 (30) 417724-0 • Fax: -50
E-Mail: catalog-info@neumann.com • Website: www.neumann.com

Errors excepted, subject to changes • Printed in Germany • Publ. 02/2014 515967/A09
 ® Neumann is a registered trademark of the Georg Neumann GmbH in certain countries
 Solution-D is a registered trademark of Georg Neumann GmbH in certain countries

